



FLAMEPROOF
MOTORS

26

ORANGE®



elprom





elprom

- Series of aluminium motors completely modular.
- The feet and flanges can be mounted without affecting the Ex type of protection.
- This permits a big advantage in the warehouse management.
- Applying feet and flanges it is possible to realize every requested mounting arrangement and this operation can be made without any problem for ATEX and IECEx motor approval.



FLAMEPROOF MOTORS

ORANGE



1	TOLERANCES AND STANDARDS OF REFERENCE	4
1.1	Mechanical and Electrical tolerances	4
1.2	Standards of reference	4
2	GUIDE TO MOTOR CHOICE	5
3	MOTOR CHARACTERISTICS	7
3.1	Range of motors	7
3.2	Testing and certificates	7
3.3	Main features	8
3.4	Main Options	9
3.5	Motors identification	10
4	TERMINAL BOX, CABLE ENTRIES AND CONNECTIONS	11
5	MECHANICAL CHARACTERISTICS	12
5.1	Permissible radial and axial forces on the shaft end	13
6	SPARE PARTS, OVERHAULS AND REPAIRS	14
6.1	Personnel qualification	14
6.2	Spare parts	14
7	ELECTRICAL DATA	14
8	OVERALL DIMENSIONS	21

1.1 Mechanical and Electrical tolerances

Symbol	Description	Tolerance	
A	Distance between centre-lines of fixing holes (end view)	± 1 mm	
AB	Overall dimensions across the feet (end view)	2,00%	
AC	Diameter of the motor (without terminal box)	2,00%	
B	Distance between centre-lines of fixing holes (side view)	± 1 mm	
C - CA	Distance from the shaft end shoulder to the centre-line of nearest mounting holes in the feet	± 3 mm	
D - DA	Diameter of the shaft extension.	∅ 11 – 28 ∅ 32 – 48 ∅ ≥ 55	j6 k6 m6
E - EA	Length of the shaft extension from the shoulder	∅ < 55 mm ∅ > 60 mm	
F - FA	Width of the keyway of the shaft extension	h9	
GA - GC	Distance from the top of the key to the opposite surface of the shaft extension	+ 0,2 mm	
H	Distance between the centre-line of the shaft to the bottom of the feet	H ≤ 250 H ≥ 280	-0,5 mm -1 mm
HD	Distance from the top of the terminal box and to the bottom of the feet	2,00%	
K	Diameter of the holes or width of the slots in the feet of the motor	3,00%	
L	Overall length of the motor with a single shaft extension	1,00%	
M	Pitch circle diameter of the fixing holes	± 0,8 mm	
N	Diameter of the spigot	∅ < 230 j6 ∅ ≥ 250 h6	
P	Outside diameter of the flange	± 1 mm	
R	Distance from the shaft shoulder to the mounting surface of the flange	± 3 mm	
S	Diameter of the fixing holes in the mounting flange or nominal diameter of thread	3,00%	
	Distance from the shaft shoulder to the mounting surface of the flange with locked bearing	± 0,5 mm	
	Mass of the motor	- 5 a + 10 %	
Nominal voltage, V _N		±5%	
Efficiency, η		-15% of (1-η)	
Power factor, cos φ		-1/6 of (1-cos φ) min 0.02, max 0.07	
Slip (rpm) (full load and nominal ambient temperature), P _N		±20% if P _N ≥ 1 kW ±30% if P _N < 1 kW	
Locked rotor current, I _A		+20%	
Locked rotor torque, M _A		-15% +25%	
Breakdown torque, M _{max}		-10% con M _{max} /M _N ³ 1.6	
Minimum torque, M _{min}		-15%	
Moment of Inertia, J		±10%	
Sound intensity level (sound pressure) L _{p(A)}		+3 dBA	

1.2 Standards of reference

Title	EU CENELEC	International IEC
Rotating electrical machines Part 1: Rating and performance	EN 60034-1	IEC 60034-1
Rotating electrical machines Part 2-1: Standard methods for determining losses and efficiency from tests (excluding machines for traction vehicles)	EN 60034-2	IEC 60034-2
Rotating electrical machines. Part 5: Degrees of protection provided by the integral design of rotating electrical machines (IP code). Classification	EN 60034-5	IEC 60034-5
Rotating electrical machines Part 6: Methods of cooling (IC Code)	EN 60034 -6	IEC 60034 -6
Rotating electrical machines Part 7: Classification of types of construction, mounting arrangements and terminal box position (IM Code)	EN 60034-7	IEC 60034-7
Rotating electrical machines Part 9: Noise limits	EN 60034-9	IEC 60034-9
Rotating electrical machines Part 12: Starting performance of single-speed three-phase cage induction motors	EN 60034-12	IEC 60034-12
Rotating electrical machines Part 14: Mechanical vibration of certain machines with shaft heights 56 mm and higher - Measurement, evaluation and limits of vibration severity General purpose three-phase induction motors having standard dimensions and outputs. Frame numbers 56 to 315 and flange numbers 65 to 740	EN 60034-14	IEC 60034-14
	EN 50347	IEC 60072-1
Degrees of protection provided by enclosures (IP Code)	EN 60259	IEC 60529
Electrical apparatus for explosive gas atmospheres Part 0: General requirements	EN 60079-0	IEC 60079-0
Electrical apparatus for explosive gas atmospheres Part 1: Flameproof enclosures "d"	EN 60079-1	IEC 60079-1
Electrical apparatus for explosive gas atmospheres Part 7: Increased safety "e"	EN 60079-7	IEC 60079-7
Explosive atmospheres Part 31: Equipment dust ignition protection by enclosure "t"	EN 60069-31	IEC 60079-31



First step is the classification of hazardous places in zones.

The end user shall classify the hazardous areas under his own responsibility.

Directive 1999/92/EC provides information regarding 'Classification of places where explosive atmosphere may occur'.

The corresponding standards of reference are EN 60079-10-1 for gas and EN 60079-10-2 for dust.

Here below we give you a synthetic step by step guide to the choice of the motors. We will highlight all the characteristics of our motors.

Zone Classification (presence of explosive atmosphere)			Electrical apparatus ATEX marking					
			(1) Group	(2) Category	(3) Type of protection	(4) Gas group Dust group	IP Degree	5) GAS Temperature class (6) DUST Surface temperature
GAS	0	Present continuously or for long period	II	1G	Electrical apparatus not allowed			
	1	Occur in normal operation occasionally	II	2G	Ex eb 'increased safety'	IIA, IIB, IIC	IP54	T1=450°C T2=300°C T3=200°C T4=135°C T5=100°C T6=85°C
					Ex db 'flameproof enclosure'			
2	Rarely occur in normal operation and for short period	II	3G	Ex nAc 'non sparking'	IIA, IIB, IIC	IP54	T1=450°C T2=300°C T3=200°C T4=135°C T5=100°C T6=85°C	
POLVERI	20	Present continuously or for long period	II	1D	Electrical apparatus not allowed			
	21	Occur in normal operation occasionally	II	2D	Ex tb 'protection by enclosure †'	IIIC, IIB, IIIA	IP6X	T125°C
	22	Rarely occur in normal operation and for short period	II	3D	Ex tc 'protection by enclosure †'	IIIB, IIIA	IP5X	

(1) **Group II:** comprises equipment intended for use in other places likely to become endangered by explosive atmospheres (surface plants different from mines).

(2) Group II is sub-divided into 3 categories: Category 1: very high level of protection
Category 2: high level of protection
 Category 3: normal level of protection

G explosive atmosphere consisting of a mixture with air and flammable substances in the form of gas, vapour or mist
D explosive atmosphere in the form of a cloud of combustible dust in air

(3) Elprom motors O-M series can have the following types of protection:

Ex db motor and terminal box (GAS)
Ex dbeb motor Ex d and terminal board Ex e (GAS)
Ex tb protection by enclosure † (DUST)

GAS GROUP	IIIC	Hydrogen, Acetylene, carbon disulfide
	IIB	Diethyl ether, Ethylene etc.
	IIA	Propane, Butane, pentane, natural gas etc.
DUST GROUP	IIIC	Conductive dust
	IIIB	Non-conductive dust
	IIIA	Combustible fibers

(5) **(GAS)** In function of their maximum surface temperature the motors are classified in a **temperature class**.

(6) **(DUST)** The **surface temperature** must be less or equal than the minimum value between Tmax1 e Tmax2 where:

$T_{max1} = 2/3 \cdot T_{cl}$ with T_{cl} ignition temperature in °C of the dust cloud.
 $T_{max2} = T_I - 75$ °C with T_I ignition temperature in °C of a 5mm layer of dust.

GAS- Main inflammable substances

Inflammable substance	Group of GAS	temperature of ignition	Temp. Class	Inflammable substance	Group of GAS	temperature of ignition	Temp. Class
2-Methylpentane	IIA	300	T2	Ethyl formate	IIA	440	T2
Amyl acetate	IIA	360	T2	Methyl formate	IIA	450	T1
Butyl-n acetate	IIA	425	T2	Natural gas	IIA	482	T1
Ethyl acetate	IIA	426	T2	Isobutane	IIA	460	T1
Isobutyl acetate	IIA	420	T2	Isoheptane	IIA	220	T3
Methyl acetate	IIA	502	T1	Isohexane	IIA	264	T3
Propil acetate	IIA	430	T2	Isooctane	IIA	410	T2
Vinyl acetate	IIA	425	T2	Isoprene	IIA	220	T3
Acetone	IIA	465	T1	Methane	IIA	537	T1
Methanol	IIA	464	T1	Methylcyclopentane	IIA	258	T3
Brome thane	IIA	511	T1	Methylamine	IIA	430	T2
Butane	IIA	287	T3	Methylmetacrylate	IIA	430	T2
Butane - 1	IIA	384	T2	Paraldehyde	IIA	239	T3
Butane - 2	IIA	325	T2	Pentane	IIA	258	T3
Cycloexano	IIA	259	T3	Pyridine	IIA	483	T1
Cycloexanol	IIA	300	T2	Propane	IIA	470	T1
Cyclohexanone	IIA	419	T2	Propylamine	IIA	318	T2
Cyclohexene	IIA	244	T3	Propylbenzene	IIA	450	T1
Cyclopropane	IIA	498	T1	Propylene	IIA	455	T1
Cymene (p)	IIA	436	T2	Styrene	IIA	490	T1
Chloro-benzene	IIA	637	T1	Toluene	IIA	480	T1
Acetyl chloride	IIA	390	T2	m-Xylene	IIA	522	T1
Allyl chloride	IIA	390	T2	o-Xylene	IIA	464	T1
Chlorbutane	IIA	240	T3	p-Xylene	IIA	528	T1
Chloroethane	IIA	495	T1	1,2 Butadiene	IIB	430	T2
Vinyl chloride	IIA	472	T1	1,3 Butadiene	IIB	430	T2
Dichlorobenzene	IIA	648	T1	Dioxane	IIB	245	T3
Dichloroethylene 1,1	IIA	570	T1	Diethyl ether	IIB	160	T4
Dichloroethylene 1,2	IIA	441	T2	Ethyl vinyl ether	IIB	200	T3
Diethylamine	IIA	312	T2	Methyl vinyl ether	IIB	350	T2
Dimethylamine	IIA	400	T2	Acrylate ethyl	IIB	350	T2
Dimethylaniline	IIA	371	T2	Ethylene	IIB	425	T2
Dimethylbutane 2,3	IIA	405	T2	LPG	IIB	365	T2
Dimethylpentane 2,3	IIA	330	T2	Sulphurated Hydrogen	IIB	260	T3
Heptane	IIA	215	T3	Methylacrylate	IIB	415	T2
Hexane	IIA	233	T3	Carbon monoxide	IIB	605	T1
Heptane	IIA	515	T1	Ethylene oxide	IIB	435	T2
Ethylacetacetate	IIA	350	T2	Propylene oxide	IIB	430	T2
Ethylamine	IIA	385	T2	Acetylene	IIC	305	T2
Ethylmercaptane	IIA	295	T3	Hydrogen	IIC	500	T1
Butyl formate	IIA	320	T2	Carbon disulfide	IIC	95	T6

DUST- Main inflammable substances

	Substance	Medium largeness particles (m)	LEL (g/m ³)	Cloud ignition temperature T _{cl} (°C)	Layer 5mm thick ignition temperature T _l (°C)
Metals, alloys	Aluminium	10	60	560	430
	Bronze	18	750	390	260
	Iron	12	500	580	>450
	Graphite	7	30	600	680
	Lamp-black (carbon black)	13	15	620	435
	Sulphur	20	30	280	260
Wood, products of wood, fibres	Paper		100	620	370
	Cellulose (93% sweet wood, 6% hard wood)	14	15	420	335
	wood flour	60		470	305
	Wood (50% pear tree and 50% kernel)	35	100	500	340
	Wood (beech)	61		490	310
	Wood (pear tree)	27	100	500	320
	Sawdust of wood	65		470	290
	Cork	42	30	470	300
Agricultural products	Cacao	3	125	460-540	245
	Coffee	10	25	360	450
	Cereals (mixed powders)	37	125	510	300
	Wheat flour	56-125	60	480	>450
	Soy flour	20	200	620	280
	Gelatine	65	60	560	>450
	Wheat		100	470	220
	Dry milk	165	60	460	330
	Milk sugar	22	60-125	450	>450
	Rye			415-470	325
	Buttermilk	400		450	420
	Tobacco		60	485	290
	Black tea	76	125	510	300
Sugar	32	30	360	>450	
Powdered sugar	17	60	350	>450	

3.1 - Range of motors

Ex Elprom motors are manufactured in compliance with all the European standards concerning equipment and protective systems for potentially explosive atmosphere in compliance with the European Directive ATEX 94/9/CE (better known as ATEX).

Here below in the table we show you the range of motors for each type of protection.

In the following pages we will talk about testing and certificates, main features of these motors and possible options always depending on the type of protection.

Range of motors						
Type	Frame size	Pole N°	Output range (kW)	Type of protection	Temperature class Surface temperature	Tamb max range
3-ph (*) 1 speed	56-132	2	0,12 – 11	Ex db Ex dbeb Ex tb	T3 T4 T5 T125°C	Ta –40°C +60°C Ta –40°C +60°C Ta –40°C +40°C Ta –40°C +60°C
	56-132	4	0,12 – 9,3			
	56-132	6	0,18 – 5,5			
	71-132	8	0,18 – 3			
3-ph 2 speeds Constant Torque	71-132	4/2	0,22/0,33 – 6/8	Ex db Ex dbeb Ex tb	T3 T4 T125°C	Ta –40°C +60°C Ta –40°C +60°C Ta –40°C +60°C
	71-132	8/4	0,11/0,18 – 3/5,5			
	71-132	6/4	0,11/0,18 – 3,3/5,2			
	71-132	8/6	0,08/0,12 – 2/3			
3-ph 2 speeds Quadratic Torque	71-132	4/2	0,06/0,25 – 2,8/9,2	Ex db Ex dbeb Ex tb	T3 T4 T125°C	Ta –40°C +60°C Ta –40°C +60°C Ta –40°C +60°C
	71-112	8/4	0,05/0,25 – 1,85/7,5			
	80-112	6/4	0,1/0,3 – 2/6,6			
	80-112	8/6	0,09/0,33 – 1,5/3,7			
1-ph (**) 1 speed	56-112	2	0,09 – 4	Ex db Ex dbeb Ex tb	T3 T4 T125°C	Ta –40°C +60°C Ta –40°C +60°C Ta –40°C +60°C
	56-112	4	0,06 – 3			

3.2 - Testing and certificates

Motors for hazardous areas have to be officially approved by a recognized test organization, authorized to issue test certificates, to ensure compliance with standards for this type of equipment.

Motors are defined and classified according to the categories and protection type which are defined in the corresponding standards. Depending on the nature of the atmosphere, it is responsibility of the user to determine which group and which maximum surface temperature should be specified for the motor installation.

The Ex motors manufactured by Elprom are manufactured in compliance with all the European and International standards concerning equipments and protective systems for explosive atmosphere (European Directive 94/9/CE better known as ATEX, and IECEx Scheme). The motors have been tested by a Notified Laboratory which released:

- EC Type Certificate , Product Quality assurance Notification (ATEX)
- CoC Certificate of Conformity, ExTR Test Report, QAR Quality assurance Report

It means that all the Ex motors are manufactured in compliance with the technical drawings and documents approved by the Notified Body after testing the motors (performing type test as written in the EN standards) and the production of such motors follows all the procedures requested by the Directive.

Every year the Production of Ex motors is evaluated by a Notified Body in order to verify that all the procedures are constantly respected.

Each motor or batch of motors will be despatched together with the following documents:

- EC Declaration of Conformity / IECEx CoC copy
- Installation manual and safety instructions where are written all the indication regarding the installations of the motors and the important instructions regarding the type/s of protection of the motors.

3.3 - Main features

ELPROM Ex electric motors are manufactured and tested in compliance with all the EN/IEC standards and also in compliance with the main European Directives (94/9/EC 'ATEX', 2004/108/EC 'EMC Electro Magnetic Compatibility', 2006/42/EC 'Machinery', 2011/65/CE 'RoHS') and with IECEx Scheme (only for Ex db and Ex tb protection)

ATEX characteristics:

- Suitable for Surface plants different from mines (Group II)
- Presence of GAS: Zone 1 and Zone 2
- Type of protection 'Ex db' or 'Ex dbeeb'
- GAS group IIC, IIB and IIA
- Temperature class T3, T4 E T5 (suitable also for T2, T1)
- Ambient temperature range
 - 40°C +60°C for temperature class T3
 - 40°C +60°C for temperature class T4
 - 40°C +40°C for temperature class T5
- Presence of DUST: Zone 21 and Zone 22
- Dust group IIIC, IIIB, IIIA
- Type of protection Ex tb IP66 (IP65 for Ex dbeeb)
- DUST groups IIIC, IIIB, IIIA
- Surface Temperature T125°C
- Ambient temperature range -40°C +60°C

All the motors are asynchronous with squirrel cage rotor, wound stator, closed and externally ventilated in compliance with EN 60034-6 (IC 411).

The supply voltages allowed can exceed the nominal value of $\pm 5\%$ (Except for IECEx motors)

All the electrical and mechanical features and the testing methods comply with the standard EN 60034-1.

The power ratings and the dimensions of the motors comply with EN 50347 and IEC 60072-1, the mounting arrangements B3, B5, B14 comply with EN 60034-7. All the geometrical dimensions are unified according to the tables UNEL 13113-71; 13117-71; 13118-7; IEC 60072-1.

The IP degrees of protection of the motors comply with IEC/EN 60034-5 and EN 60259.

Insulation class. All the motors have an insulation class F in compliance with IEC/EN 60034-1. Insulation class H on request.

The bearings are single row deep grooves ball bearings, preloaded by a wave spring.

Duty. The motors are normally made for S1 duty; otherwise intermittent duties can be provided on request after performing the heating tests.

Single-phase motors: Capacitor placed in a safe Ex d cylindrical box fitted to the motor.

Windings: Made using enamelled copper wires are insulated with two layers (insulation class H). They are painted with another layer of varnish and after this placed in an oven for the drying process. It is also possible to tropicalize the windings using special additional varnish with high hygroscopic characteristics so to be used in places with an humidity $> 60\%$ (see options)

Rotors Die-cast aluminium squirrel cage or aluminium alloy (Al-Si Silumin).

The shafts of the motors and the keys-shaft comply IEC 60072-1. Special shaft are made on request (see options).

Frame (in compliance with EN 50347). Die-cast aluminium with high mechanical strength, with a good thermal conductivity and light weight. The feet can be mounted on the motor frame in 3 different positions, in the bottom or on right and left side.

Terminal box. The terminal box in case of motor B3, is normally on the top of the motor. As the feet are removable also on the sides of the frame it is possible to have the terminal box on both sides of the motor too.

Flanges and shields (in compliance with EN 50347.1). Die-cast aluminium, with dimensions as per standard IEC 60072-1, or with special shapes on request: The motor is completely modular so that the flanges can be mounted or removed depending on the needs without affecting the Ex type of protection (as the flange are mounted on the front shield).

Ventilation (in compliance with EN 60034-6). Self-ventilated motors IC 411. Depending on the type of protection the fan can be in plastic or in aluminium.

Ex db, Ex dbeeb Plastic fan

Ex tb Antistatic plastic or aluminium fan

Fan cover Zinc-plated steel sheet.

Noise (in compliance with iec/EN 60034-9)

3.4 - Main Options

Axially locked shaft

Motors with a locked bearing on the front shield using an elastic metal ring. This solution is necessary in case of alternative axial stress (ie. Bevel gear pinion with alternative load or motion, frequent start-up under load or with high inertia) so to create axial movement of the shaft and bumps on the bearings.

Low temperatures motors (-40 °C)

They have to be fitted with special bearing, metallic fan, metallic cable gland and plugs or made with special plastic materials. In these cases, if there is a risk of condensation, it is better to fit the motors with "anti-condensation heaters".

Anti-condensation Heaters

For motors installed in cold and wet places, with significant temperature ranges, moisture condensation can be dangerous for the resistance of the winding insulation. Upon request, we can apply appropriate heaters directly on the heads of winding.

The terminals are connected to a terminal board inside the connection box of the motor.

The heaters are available at 110V and 220 V , with a tolerance of +/- 10%

Tropicalization of windings

If the motors are installed outdoors or in high humidity areas, the windings may be tropicalized with a special varnish with high hygroscopic characteristics in order to protect the insulation materials by the condensation. This protection avoid the reduction of the insulation properties of the windings.

Inverter duty motors

All these motors can be driven by a converter. In this case they must be fitted with thermal protections inside the windings.

Special voltages and frequencies

The standard three phase motors are produced at the following nominal voltages and frequencies:

230 / 400 V , 50 Hz. The motors can run at a different nominal voltage with a tolerance of +/- 5% (Except for IECEx motors)

On customer request, we can produce motors with special voltage and frequency.

Special shafts

On customer request, it is possible to supply motors with special shaft (according to the customer drawing). It is necessary to send the drawing to our Technical Department for a feasibility study.

It is possible to supply motors with shaft of different material from the standard (C40), using Stainless Steel or others, with standard or special dimensions.

Special flanges

Due to the modular flange assembling is possible to have, on request special flanges.

Rain fan cover

For outdoor applications, vertical mounting, DE shaft down (V5, V1, V18) it is suggested to assemble a special cowl with a rain cover. It is available for all the frame sizes.

Thermistors (PTC Positive Temperature Coefficient)

They must be used in case of motors driven by inverters.

They are fitted inside the windings in number of 3 with a series connection to be connected to an appropriate tripping device that cut off the motors supply in case the winding reach the thermal probe limit temperature. On request will be available protectors with different temperature setting in respect of the maximum temperature class or surface temperature of the motor.

Thermal cut-off (bimetallic probes)

Motors with 1 or 2 thermal protectors with normally closed contact in series connection into the winding.

The series of contact shall be connected to an appropriate tripping device that cut off the motors supply in case the winding reaches the thermal probe limit temperature. On request will be available protectors with different temperature setting in respect of the maximum Temperature class or surface temperature of the motor.

PT100

It is a device that increase its resistance according with the increasing of the temperature.

It is useful for continuous measuring of the winding temperature, properly connected to an electronic equipment.

Single-phase motor with balanced winding - BIPHASE

They have normally a starting torque higher than the standard 1-phase and can start easily without using a start capacitor.

Painting (against corrosion)

The Elprom motors have diecasted aluminium components and sandblasted. If it is not requested the motors are supplied unpainted.

On specific request and for batches not less than 30 pcs. , it is possible to have motors with epoxy paint, with the customer requested colour. Other paints with anti salt characteristics are available on request; contact our Technical Department.

3.5 Motors identification

Motor Type				OD
MD	Single-phase Ex d	ME	Single-phase Ex de	
OD	Three-phase Ex d	OE	Three-phase Ex de	

Motor shaft height		063
56, 63, 71, 80, 90, 100, 112, 132		

Stator dimensions		A
A, B	56, 63, 71, 80	
S, L	90, 132	
K, M	100, 132	
M	112, 132	

Poles		4
2, 4, 6	Single-phase motors	
2, 4, 6, 8	Three-phase motors 1 speed	
3, 5, 7, 9	Three-phase motors 2 speeds 2/4, 4/8, 4/6, 6/8 poles	

Mounting arrangements				H
H	B3	W	B3/B14	
B	B3 right box	X	B3/B5	
S	B3 left box	J	B3/B14 left box	
F	B5	M	B3/B14 right box	
G	V1 (B5 + rain cover)	R	B3/B5 left box	
Q	B14	T	B3/B5 right box	

Supply voltage		230
For 3ph 1 speed is indicated the lower voltage (ex. 230 for 230/400)		

Frequency		5
5	50Hz	
6	60Hz	
7	50/60Hz	

Protection (IP and Ex)		P
P	IP66 motors Ex d or Ex de	
Q	IP66 – motors 'Ex d or Ex de' plus 'Ex tD'	

Temperature class		4
3	Temperature class T3 (200°C)	
4	Temperature class T4 (135°C)	
5	Temperature class T5 (100°C)	

Thermal protectors		U
-	Without thermal protectors	
3	Thermal protector (PTO) – Temperature class T3	
4	Thermal protector (PTO) – Temperature class T4	
5	Thermal protector (PTO) – Temperature class T5	
P	PTC – temperature class T3	
U	PTC – temperature class T4	
V	PTC – temperature class T5	

As the feet can be mounted on the frame, it is possible to fix them in 3 different positions so to have the possibility to have the terminal box on the top or on the right and left sides of the motor (see picture 1)

At the same time the terminal box can be mounted on the motor so to have the cable entries where it is necessary. So the cable entries can be in the four different positions (see picture 2).

Terminal box and cable entries



Figura 1



Figura 2

Motor size	cable glands			
	EX d motor		Ex de motor	
	Mains	Aux	Mains	Aux
63	M20	M20	M20	M20
71	M20	M20	M20	M20
80	M20	M20	M20	M20
90	M20	M20	M20	M20
100	M20	M20	M20	M20
112	M20	M20	M20	M20
132	M25	M20	M25	M20

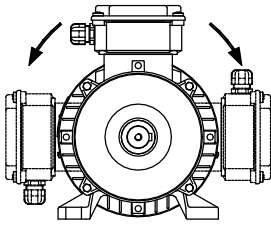
Cable connection on the terminal board

Motors 'Ex d' (only ATEX approved)

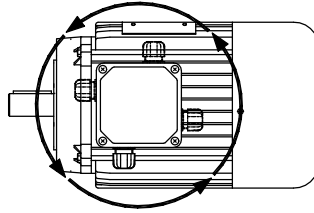
The flameproof motors with increased safety terminal box are built with a special terminal board and the cable glands shall be certified in compliance with EN 60079-7.

In the picture you can see the special terminal board complying with EN 60079-7. In case of motor fitted with thermal protection heaters etc. the wires of these devices will be connected when possible to the auxiliary pins of a 8 pins terminal board. If it is not possible they must be connected to the cable by welding the wires of the device to the cable wires and insulating them using a thermo sheath.

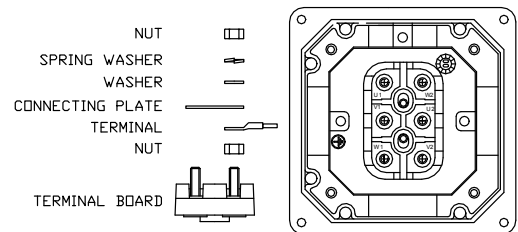

Motors 'Ex d'

For these type of motors there is no need of a special terminal board and the cable glands shall be certified in compliance with IEC/EN 60079-1.

Wiring diagrams

3-ph 1 speed

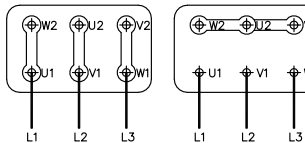

Delta connection (lower voltage)

Star connection (Higher voltage)

3-ph 1 speed

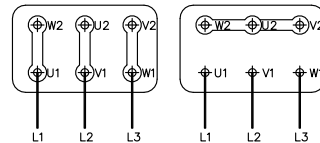

Delta connection (lower voltage)

Star connection (Higher voltage)

3-ph - 2 speeds - 1 winding Dahlander

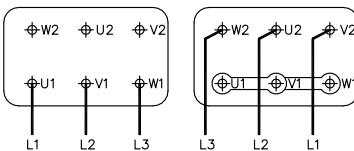

Low speed

High speed

3-ph - 2 speeds - 2 separate windings

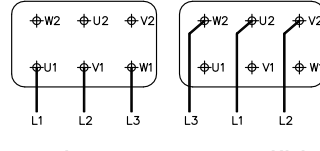

Low speed

High speed

1-ph - run capacitor (4 wires)

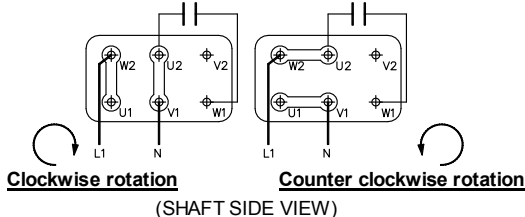

Clockwise rotation

Counter clockwise rotation

(SHAFT SIDE VIEW)

1-ph - run capacitor (3 wires)

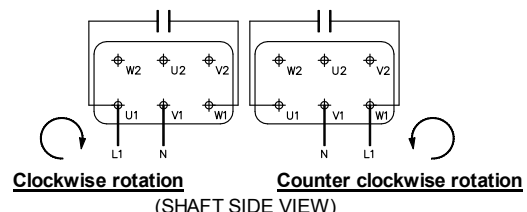

Clockwise rotation

Counter clockwise rotation

(SHAFT SIDE VIEW)

Mounting arrangements

Foot mounted

IM 1001 (IM B3)

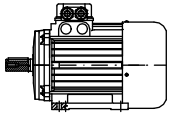

IM 1051 (IM B6)

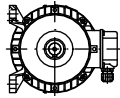

IM 1061 (IM B7)

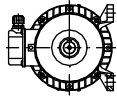

IM 1071 (IM B8)

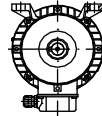

M 1011 (IM V5)

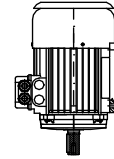

IM 1031 (IM V6)

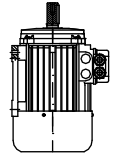

Flange mounted

IM 3001 (IM B5)

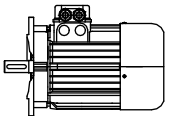

IM 3011 (IM V1)

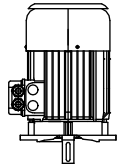

IM 3031 (IM V3)

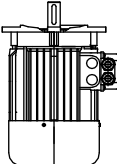

IM 3601 (IM B14)

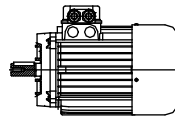

IM 3611 (IM V18)

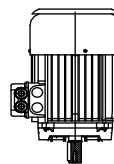

IM 3631 (IM V19)

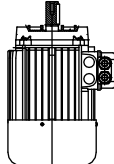

Foot-flange mounted

IM 2001 (IM B35)

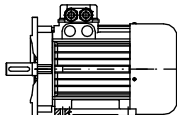

IM 2011 (IM V15)

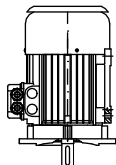

IM 2031 (IM V36)

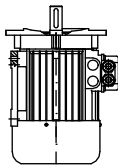

IM 2101 (IM B34)

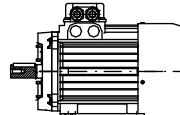

IM 2111 (IM V58)

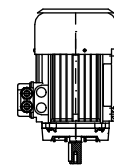

IM 2131 (IM V69)

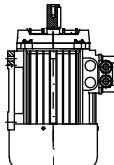

In the table here below we show the main components of the motors and the material they are made of.

Main components

Component	Material	Note
Frame	Aluminium	Removable feet (aluminium)
End- shields	Aluminium	
Flange B5	Aluminium	
Flange B14	Aluminium	
Terminal box	Aluminium	
Shaft	Steel C40	
Rotor	Magnetic lamination die-cast aluminium	
Stator	Magnetic lamination	
Windings	enamelled copper wires (two layers)	
V-Ring	NBR rubber	Special material: VITON
Bearings	Deep groove ball bearings	See Below
Fan	Plastic (Ex D, Ex de), Aluminium or antistatic plastic (Ex tb)	

Bearings and seals

Motor size	Bearings		Seals	
	Drive end	Non-drive end	Drive end	Non-drive end
63	6202-ZZ	6202-ZZ	v-Ring Ø15	v-Ring Ø15
71	6202-ZZ	6202-ZZ	v-Ring Ø15	v-Ring Ø15
80	6204-ZZ	6204-ZZ	v-Ring Ø20	v-Ring Ø20
90	6205-ZZ	6205-ZZ	v-Ring Ø25	v-Ring Ø25
100	6206-ZZ	6206-ZZ	v-Ring Ø30	v-Ring Ø30
112	6306-ZZ	6306-ZZ	v-Ring Ø30	v-Ring Ø30
132	6308-ZZ	6308-ZZ	v-Ring Ø40	v-Ring Ø40

The motors are normally fitted with permanently greased bearings of type ZZ, lubricated with a special grease G-15 and have a service max temperature of 150°C.

The bearing life time for aluminium motors is approximately (depending on application and load conditions):

- 2 and 2/4 pole motors, 10 000 - 20 000 duty hours
- 4 to 8 pole motors, 20 000 - 40 000 duty hours

Both on drive end and non-drive end are mounted V-ring seals in order to have the IP66 protection.

5.1 - Permissible radial and axial forces on the shaft end

The following tables give the permissible radial and axial forces in Newton.

5.1.1 - Permissible radial load

The following tables give the permissible radial and axial forces in Newton.

Here we show the permissible radial load (FR) that can be applied to three different positions (X0, L/2 and L where L is the length of the shaft axis) on the shaft-end, supposing motors running at 50Hz and bearings life time at least 20,000 hours for 2 poles motors and 40,000 hours for 4-6-8 poles. For service on 60Hz reduce values by 10%. Take the higher speed as reference for double pole motors.

This the formula to calculate FR in a point of the shaft with generic position X: $F_R = F_{X0} - (F_{X0} - F_L)X/L$

Permissible radial load													
Motor size	Shaft length L (mm)	2 poles			4 poles			6 poles			8 poles		
		X0	L/2	L	X0	L/2	L	X0	L/2	L	X0	L/2	L
63	23	390	365	340	390	365	340	450	420	390	-	-	-
71	30	490	450	410	490	450	410	560	515	470	610	565	520
80	40	650	590	530	650	590	530	750	680	610	820	745	670
90S	50	720	645	570	720	645	570	820	735	650	910	815	720
90L	50	720	650	580	720	650	580	830	750	670	920	830	740
100	60	1020	920	820	1020	920	820	1160	1045	930	1290	1165	1040
112	60	1410	1280	1150	1410	1280	1150	1610	1455	1300	1780	1610	1440
132	80	1510	1345	1180	1510	1345	1180	1510	1430	1350	1910	1700	1490

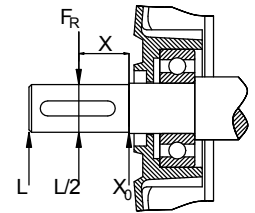

For Belt drive applications the maximum radial load FR is given by:

FR = maximum radial load (N) = (P + F) where:

- P = pulley weight (N)
- F = belt tension (N) = $(2 \cdot K \cdot M)/D$ where:
- K = belt tension factor (K = 3 for normal flat belt without idler pulley; K = 2,2 for V-belt; K = 2 for normal flat belt with idler pulley)
- D = pulley diameter (m)
- M = torque (Nm) = $9550 \cdot P/n$ where:
- P = output (kW)
- n = speed in (1/min)

5.1.2 - Permissible axial load (with additional radial load applied at the end of the shaft)

In the table below we show the additional axial load (FA) allowable if the maximum radial load (FR) is applied on L.

The lower is radial load, the bigger is allowable axial load.

Axial load calculations have been carried out in three different foot mounting operating conditions: horizontal (B3), vertical shaft-down (V5) and vertical shaft-up (V6), supposing the case of thrust T or pull P force.

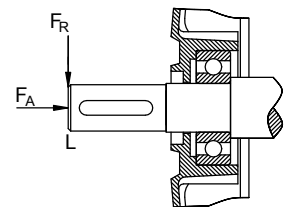

Permissible radial load

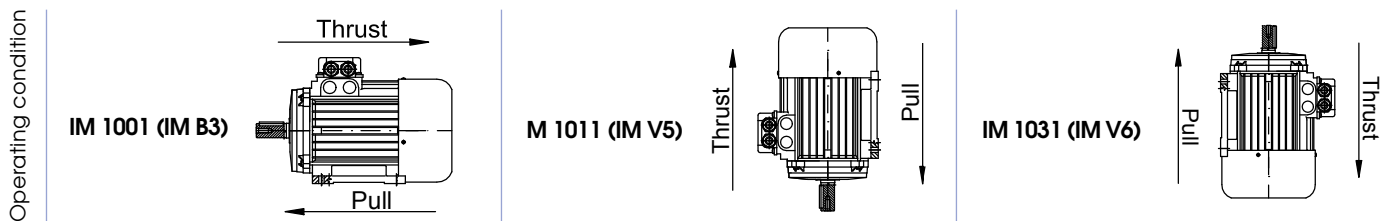

Motor size	2 poles		4 poles		6 poles		8 poles		2 poles		4 poles		6 poles		8 poles		2 poles		4 poles		6 poles		8 poles	
	T	P	T	P	T	P	T	P	T	P	T	P	T	P	T	P	T	P	T	P	T	P	T	P
63	240	110	240	110	280	120	290	120	250	100	250	100	290	110	290	110	230	120	130	120	270	130	280	130
71	300	140	300	130	350	160	380	170	320	120	320	110	370	140	400	150	280	160	280	150	330	180	360	190
80	400	190	400	180	460	210	510	240	430	160	440	140	500	170	550	200	370	220	360	220	420	250	470	280
90S	430	200	430	210	500	230	550	260	460	170	470	170	540	190	590	220	400	230	390	250	460	270	510	300
90L	440	200	440	200	510	240	560	260	480	160	490	150	560	190	610	210	400	240	390	250	460	290	510	310
100	620	290	610	290	710	330	780	370	680	230	690	210	790	250	860	290	560	350	530	370	630	410	700	450
112	860	400	850	400	980	460	1080	500	950	320	960	290	1090	350	1190	390	780	480	740	510	870	570	970	610
132	910	440	910	430	1040	500	1150	550	1050	300	1080	260	1210	330	1320	380	770	590	740	610	870	670	960	720

6

SPARE PARTS, OVERHAULS AND REPAIRS

6.1 - Personnel qualification

Overhauls and repairs must be carried out only by qualified people in accordance with the standard EN 60079-17 or national standards (last edition). Qualified people must have knowledge about explosion protection. Repairs must be made regarding the rules as define in EN 60079-19 standard. These repairs can only be done under the control or in agreement with ELPROM or by an ATEX and IECEx certified workshop. In case these rules are not respected, the product won't be covered by Elprom ATEX and IECEx certifications anymore.

6.2 - Spare parts

All motors components must be replaced with original spare parts. In these case contact ELPROM directly and provide the serial number of the motor in order to be authorized for the repair or the motor itself.

List of main spare parts

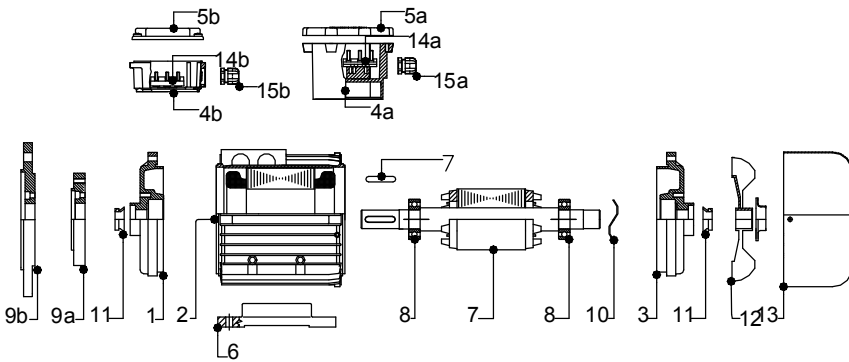

1	Drive End shield
2	Frame complete with winding
3	Non Drive End shield
4a	Ex d terminal box
4b	Ex e terminal box
5a	Ex d Terminal box cover
5b	Ex e terminal box cover
6	Feet (removable)
7	Shaft complete of rotor and key
8	Bearings
9a	B14 flange (removable)
9b	B5 flange (removable)
10	Wave spring
11	Shaft seals (V-ring)
12	Fan (complete of fixing collar)
13	Fan cover
14a	Ex d terminal board
14b	Ex e terminal board
15a	Ex d cable gland (metallic)
15b	Ex e Cable gland (plastic)

7

ELECTRICAL DATA

Here below we give some information about all the types of motors.

THREE PHASE 1 SPEED

- Asynchronous motor, squirrel cage rotor, self ventilated (IC411).
- Duty S1, Insulation class "F", 230/400V - 50 Hz.

In case of motors driven by INVERTER:

- Motor must be equipped with PTC thermistor.
- Motor driven by frequency converter means not to have a voltage and current not perfectly sinusoidal with consequently increase of losses and heating of the motor.
- Speed variation affects also the ventilation.
- The stress on the bearings increases and they shall be checked more frequently; for this reason the operating period with a speed above 3600 rpm shall never exceed 10% of the complete working cycle.

Normally the motors are 230/400V 50Hz but on request is possible to have special voltage and frequency.

THREE PHASE 2 SPEEDS

- Asynchronous motor, squirrel cage rotor, self ventilated (IC411).
- Duty S1, Insulation class "F", 400V - 50 Hz

Poles	Connections	CONSTANT TORQUE (GENERAL PURPOSE)		QUADRATIC TORQUE (CENTRIFUGAL MACHINES)	
		High Speed	Low Speed	High Speed	Low Speed
2/4 - 4/8	Dahlander	YY	Δ	YY	Y
4/6 - 6/8	2 Separate windings	Y	Y	Y	Y

SINGLE-PHASE MOTORS 1 SPEED

- Asynchronous motor, squirrel cage rotor, self ventilated (IC411).
- Duty S1, Insulation class "F", 230V - 50 Hz.

The capacitor will be fitted inside a special 'Ex d' box and mounted on the motor. In case of external capacitor, it must be placed in a safe area where an explosive atmosphere is not present.

THREE PHASE MOTORS 1 SPEED - 3000

400V 50Hz

Tipo Type	(kW)	rpm	η	$\cos\phi$	I_n (A)	M_n (Nm)	I_A/I_n	M_A/M_n	M_{max}/M_n	J_{rotor} (kgm ²)	(kg)
56B2	0,12	2850	50%	0,76	0,5	0,43	4,8	3,6	3,8	0,00016	5
63A2	0,18	2825	56%	0,76	0,62	0,61	3,9	2,6	3,6	0,00017	5,5
63B2	0,25	2750	60%	0,83	0,74	0,87	3,3	1,8	2,5	0,00022	5,5
71A2	0,37	2850	71%	0,78	1	1,24	4,5	2,4	2,7	0,00035	7,5
71B2	0,55	2840	70%	0,78	1,45	1,85	4,9	3,3	3,4	0,00045	7,5
80A2	0,75	2870	73%	0,72	2	2,5	5,3	3	4	0,00068	10
80B2	1,1	2830	72%	0,86	2,6	2,7	4,1	2	2,7	0,00088	10
90S2	1,5	2850	68%	0,83	3,95	5,1	4,2	2,4	2,6	0,00118	13,5
90L2	2,2	2840	70%	0,85	5,4	7,2	5,1	3,7	3,9	0,00180	15,5
100L2	3	2900	78%	0,82	6,8	10	5,5	2,2	3,8	0,00279	20
112M2	4	2910	78%	0,83	9,2	13,2	8,2	2,4	2,8	0,00544	28
132K2	5,5	2910	80%	0,87	11,46	18,1	5,9	2,6	2,8	0,00993	45
132S2	7,5	2920	84%	0,85	15,3	24,7	6,2	2,6	3,3	0,01316	48
132M2	9	2930	88%	0,88	19	30	7,5	2,8	3	0,01410	58
132L2	11	2940	88%	0,85	21,40	36	7	2,6	3,6	0,01520	61

THREE PHASE MOTORS 1 SPEED - 1500

400V 50Hz

Tipo Type	(kW)	rpm	η	$\cos\phi$	I_n (A)	M_n (Nm)	I_A/I_n	M_A/M_n	M_{max}/M_n	J_{rotor} (kgm ²)	(kg)
56B4	0,09	1450	50%	0,63	0,46	0,63	2,4	2,7	3,1	0,00020	5
63A4	0,12	1420	50%	0,53	0,71	0,8	2,7	3,3	3,9	0,00021	5,5
63B4	0,18	1380	53%	0,65	0,76	1,25	2,6	2,1	2,5	0,00029	5,5
71A4	0,25	1400	55%	0,81	0,84	1,7	3,8	2,1	2,8	0,00073	7
71B4	0,37	1410	66%	0,68	1,2	2,52	3,9	2,5	2,9	0,00080	7
80A4	0,55	1430	68%	0,71	1,75	3,75	4,3	2,7	3,2	0,00092	10
80B4	0,75	1410	72%	0,75	2,1	5,1	3,9	2,3	2,4	0,00128	11
90S4	1,1	1420	71%	0,7	3,3	7,5	3,7	2,8	3,2	0,00203	13,5
90L4	1,5	1415	75%	0,78	3,8	10,16	4,2	2,2	3,1	0,00265	16
100K4	2,2	1440	77%	0,77	5,8	14,5	4,9	2	2,3	0,00450	20
100L4	3	1420	84%	0,74	7,1	20,3	4,8	2	3,5	0,00599	23
112M4	4	1450	84%	0,76	9,1	26,4	4,8	2,2	3,5	0,01112	30
132S4	5,5	1455	85%	0,81	11,5	36,3	5,1	2,1	2,8	0,02311	42
132M4	7,5	1450	88%	0,82	15,6	50	5,5	2,4	3	0,02953	56
132L4	9	1460	87%	0,78	19,7	59	5,0	2,1	2,8	0,03200	60

THREE PHASE MOTORS 1 SPEED - 1000

400V 50Hz

Tipo Type	(kW)	rpm	η	$\cos\phi$	I_n (A)	M_n (Nm)	I_A/I_n	M_A/M_n	M_{max}/M_n	J_{rotor} (kgm ²)	(kg)
63B6	0,12	900	40%	0,6	0,8	1,32	1,8	2,4	2,6	0,00029	6
71A6	0,18	900	62%	0,7	0,61	1,95	3	2	2,3	0,00060	7
71B6	0,25	910	63%	0,6	1	2,7	2,9	3,1	3,3	0,00080	7,5
80A6	0,37	940	58%	0,66	1,4	3,76	4	2,7	3,2	0,00220	10
80B6	0,55	930	65%	0,65	2	5,72	2,7	2,3	2,4	0,00282	11
90S6	0,75	930	71%	0,7	2,2	7,9	3,5	2,3	2,4	0,00265	13
90L6	1,1	910	67%	0,75	3,2	11,6	3,7	2,3	2,5	0,00342	16
100L6	1,5	940	78%	0,68	4	15,3	4,1	2,6	2,9	0,01033	22
112M6	2,2	930	78%	0,78	5,2	22,6	5	3,2	3,4	0,01603	37
132S6	3	970	81%	0,73	7,8	29,6	5,3	1,7	2,7	0,03159	45
132K6	4	960	84%	0,74	9,2	40	5	2	2,9	0,03786	51
132M6	5,5	950	85%	0,74	12,5	54,2	5	1,6	2,2	0,04541	55

THREE PHASE MOTORS 1 SPEED - 750

400V 50Hz

Tipo Type	(kW)	rpm	η	$\cos\phi$	I_n (A)	M_n (Nm)	I_A/I_n	M_A/M_n	M_{max}/M_n	J_{rotor} (kgm ²)	(kg)
80A8	0,18	690	49%	0,6	0,95	2,5	2,8	2,7	3	0,00141	10
80B8	0,25	700	55%	0,55	1,2	3,6	2,9	2,8	3,2	0,00251	11
90S8	0,37	680	60%	0,67	1,3	5,2	3	1,6	2	0,00376	13
90L8	0,55	690	65%	0,65	1,9	7,7	3	2,4	2,7	0,00551	15
100K8	0,75	700	65%	0,65	2,6	10	3,4	2,3	2,5	0,00775	20
100L8	1,1	700	63%	0,69	3,6	15,2	3,7	2,2	2,6	0,01033	22
112M8	1,5	710	77%	0,72	3,9	20,2	3,7	1,3	2,2	0,01870	37
132S8	2,2	710	75%	0,76	6,4	30	3,4	1,6	2,5	0,03223	48
132L8	3	700	78%	0,79	7	41	4	1,6	2	0,04000	56

THREE PHASE MOTORS 2 SPEED - CONSTANT TORQUE - 1500/3000

400V 50Hz

Tipo Type	(kW)	Poli Poles	rpm	η	$\cos\phi$	I_N (A)	M_N (Nm)	I_A/I_N	M_A/M_N	J_{rotor} (kgm ²)	(kg)
71A3	0,22	4	1380	57	0,66	0,8	1,1	3,2	1,9	0,00050	7
	0,33	2	2760	53	0,71	1	1,4	3,8	1,8		
71B3	0,4	4	1380	68	0,62	1,2	1,6	3,2	1,9	0,00080	7,5
	0,5	2	2800	60	0,70	1,25	2,1	4,2	1,8		
80A3	0,45	4	1430	68	0,62	1,5	1,9	3,9	2	0,00140	9
	0,6	2	2880	67	0,76	1,9	2,6	4,1	2		
80B3	0,6	4	1450	67	0,71	2,2	2,6	4	2	0,00170	11
	0,8	2	2890	72	0,81	2,6	3,9	4,3	2		
90S3	0,8	4	1440	69	0,72	2,6	4,4	4,5	2,3	0,00330	13
	1,1	2	2890	73	0,82	3,4	6,4	5	2		
90L3	1,1	4	1420	69	0,76	3,2	5,6	4,3	2,4	0,00400	15
	1,6	2	2880	70	0,81	4,8	8,5	4,9	2,3		
100M3	1,5	4	1430	75	0,79	4	10,5	6	2,4	0,00750	20
	2,2	2	2850	77	0,85	5,7	16,8	6	2,3		
100L3	2,2	4	1440	77	0,85	5,7	13,8	6,2	2,5	0,00860	25
	3	2	2870	77	0,84	8,1	23,0	6	2,3		
112M3	3,3	4	1450	78	0,87	7	1,1	6,2	2,5	0,01300	30
	4	2	2900	77	0,88	9,1	1,4	6	2,3		
132S3	4,8	4	1450	84	0,87	9,5	32,0	6,3	2,2	0,02311	42
	5,9	2	2840	84	0,85	12,1	19,5	7,1	2,3		
132M3	5,5	4	1440	85	0,84	11,1	44,0	6,5	2,1	0,02953	56
	7,5	2	2860	86	0,86	13,9	25,0	7,3	2,3		
132L3	6	4	1450	85	0,84	12,1	50,0	6,2	2,2	0,03200	60
	8	2	2900	85	0,87	14,9	30,5	7,4	2,3		

THREE PHASE MOTORS 2 SPEED - CONSTANT TORQUE - 750/1500

400V 50Hz

Tipo Type	(kW)	Poli Poles	rpm	η	$\cos\phi$	I_N (A)	M_N (Nm)	I_A/I_N	M_A/M_N	J_{rotor} (kgm ²)	(kg)
71A5	0,11	8	670	40	0,72	0,8	1,3	2,4	1,4	0,00180	7
	0,18	4	1370	68	0,62	0,9	1,4	3,4	1,1		
71B5	0,15	8	670	42	0,71	1,1	1,5	2,4	1,4	0,00200	7,5
	0,3	4	1370	70	0,75	1,2	1,5	3,5	1,1		
80A5	0,22	8	700	50	0,67	1,3	2,2	2,4	1,6	0,00230	10
	0,45	4	1420	71	0,75	1,4	2,3	3,5	1,5		
80B5	0,37	8	700	54	0,69	2	3,1	2,6	1,6	0,00300	11
	0,55	4	1410	75	0,74	2,4	2,9	3,6	1,5		
90S5	0,37	8	680	62	0,70	3	4,5	3,2	1,7	0,00350	13
	0,75	4	1400	71	0,75	4,9	4,4	4	2		
90L5	0,6	8	700	67	0,70	3,2	4,5	3,2	1,7	0,00430	15
	1,1	4	1420	77	0,75	4	4,4	4	2		
100M5	0,7	8	700	70	0,68	5	6,9	5	2,5	0,00770	20
	1,1	4	1430	79	0,77	5,2	6,8	5,2	2,2		
100L5	1,1	8	710	72	0,74	5,2	9,1	5,2	2,4	0,00860	22
	1,8	4	1430	80	0,81	5,5	8,9	5,5	2,3		
112M5	1,4	8	710	78	0,65	5,3	11,5	5,2	2,5	0,01200	37
	2,6	4	1430	81	0,85	5,7	12,0	5,5	2,3		
132S5	1,85	8	700	82	0,75	4,4	25	4,1	1,6	0,03000	50
	3,3	4	1440	83	0,83	6,8	22	4,9	1,6		
132M5	2,4	8	710	82	0,76	5,5	33	4,3	1,7	0,04000	55
	4,8	4	1430	85	0,81	10	32	5,2	1,7		
132L5	3	8	720	84	0,75	7	40	4,5	1,8	0,04500	59
	5,5	4	1440	85	0,83	11,5	36	5,5	1,8		

THREE PHASE MOTORS 2 SPEED - CONSTANT TORQUE - 1000/1500

400V 50Hz

Tipo Type	(kW)	Poli Poles	rpm	η	$\cos\phi$	I_N (A)	M_N (Nm)	I_A/I_N	M_A/M_N	J_{rotor} (kgm ²)	(kg)
71BL	0,1	6	900	53	0,71	0,38	1,1	2,4	1,4	0,00080	7,5
	0,2	4	1400	70	0,75	0,55	1,3	3,3	1,4		
80AL	0,2	6	905	62	0,72	0,65	2,1	2,5	1,5	0,00220	9
	0,4	4	1400	71	0,75	1,1	2,9	3,4	1,4		
80BL	0,3	6	910	66	0,73	0,9	3,0	3,1	1,5	0,00282	10
	0,5	4	1405	71	0,74	1,38	3,4	3,6	1,5		
90SL	0,45	6	910	70	0,73	1,26	4,6	4,3	1,5	0,00265	13
	0,65	4	1405	76	0,75	1,65	4,5	5,8	1,6		
90LL	0,6	6	910	70	0,74	1,66	6,3	3,6	1,6	0,00342	16
	0,95	4	1400	77	0,76	2,36	6,4	5,5	1,5		
100ML	0,9	6	910	74	0,74	2,4	9,3	4,1	1,7	0,00775	22
	1,4	4	1415	81	0,73	3,2	9,4	5,7	1,8		
100LL	1,1	6	910	74	0,74	2,9	12,1	2,9	1,6	0,01033	26
	1,85	4	1415	80	0,81	4,1	12,4	5,8	1,6		
112ML	1,6	6	940	81	0,77	3,66	16,2	4,3	1,7	0,01603	37
	2,4	4	1420	82	0,85	4,95	16,5	6,1	1,8		
132KL	2	6	940	81	0,8	4,46	20,2	3,9	1,6	0,03223	48
	3	4	1450	82	0,87	6	20	5,9	1,9		
132SL	2,6	6	940	83	0,77	5,8	25,9	4,5	1,8	0,03600	54
	4	4	1450	83	0,82	8,4	26,3	6,1	2		
132ML	3	6	960	80	0,8	6,6	30,3	4,4	1,7	0,03800	59
	4,4	4	1440	84	0,89	9	29	6,3	1,9		
132LL	3,3	6	940	85	0,76	7,3	33	4,7	1,7	0,04000	62
	5,15	4	1440	84	0,82	10,7	33,5	6,8	1,9		

THREE PHASE MOTORS 2 SPEED - CONSTANT TORQUE - 750/1000

400V 50Hz

Tipo Type	(kW)	Poli Poles	rpm	η	$\cos\phi$	I_N (A)	M_N (Nm)	I_A/I_N	M_A/M_N	J_{rotor} (kgm ²)	(kg)
71B9	0,08	8	690	49	0,61	0,44	1,1	2,2	1,3	0,00080	7,5
	0,12	6	900	50	0,71	0,53	1,3	2,4	1,4		
80B9	0,13	8	690	52	0,60	0,63	1,9	2,1	1,5	0,00220	9
	0,15	6	935	50	0,71	0,68	1,5	2,6	1,5		
80B9	0,15	8	685	49	0,60	0,82	2,2	2,2	1,4	0,00282	10
	0,25	6	930	52	0,72	1	2,7	3,2	1,5		
90S9	0,25	8	650	60	0,60	1	3,8	3,1	2,5	0,00265	13
	0,35	6	910	55	0,74	1,35	3,6	3,8	1,4		
90L9	0,30	8	685	61	0,60	1,35	4,3	3,4	1,6	0,00342	16
	0,60	6	935	60	0,76	2	6,1	3,8	1,5		
100M9	0,55	8	700	68	0,63	1,9	7,4	3,6	1,6	0,00775	22
	0,80	6	920	65	0,77	2,35	8,2	4,0	1,5		
100L9	0,65	8	700	68	0,66	2,2	8,8	3,7	1,6	0,01033	26
	1,00	6	930	67	0,75	2,9	10,5	4,1	1,6		
112M9	1,00	8	710	65	0,70	3,3	13,4	3,9	1,6	0,01603	37
	1,50	6	960	75	0,72	4,2	15	4,0	1,7		
132S9	1,3	8	720	68	0,65	4,1	17,4	4	1,8	0,03600	54
	1,85	6	950	73	0,71	5,2	18,5	4,2	1,6		
132M9	1,85	8	720	70	0,67	5,9	24,7	4,2	1,8	0,03800	59
	2,55	6	960	75	0,73	6,9	25,2	4,1	1,8		
132L9	2	8	730	74	0,65	5,9	26,4	4,1	1,9	0,04000	62
	3	6	980	79	0,75	7,3	29,6	4,2	1,8		

THREE PHASE MOTORS 2 SPEED - QUADRATIC TORQUE - 1500/3000
400V 50Hz

Tipo Type	(kW)	Poli Poles	rpm	η	$\cos\phi$	I_N (A)	M_N (Nm)	I_A/I_N	M_A/M_N	J_{rotor} (kgm ²)	(kg)
71AC	0,09	4	1410	33	0,70	0,4	0,6	2,8	1,8	0,00050	7
	0,37	2	2790	59	0,80	1,1	1,3	3,5	1,8		
71BC	0,14	4	1410	65	0,70	0,45	1,0	2,9	1,9	0,00080	7,5
	0,50	2	2800	60	0,70	1,9	1,7	3,6	1,8		
80AC	0,18	4	1415	66	0,79	0,5	1,2	3,5	2,2	0,00140	10
	0,75	2	2800	63	0,76	2,26	2,6	4	1,8		
80BC	0,25	4	1415	70	0,81	0,64	1,7	3,7	2,2	0,00170	11
	1,10	2	2810	66	0,81	3	3,7	4,1	1,8		
90SC	0,37	4	1420	64	0,81	1	2,5	3,9	2,2	0,00330	13,5
	1,50	2	2820	66	0,82	4	5,1	4,5	2,0		
90LC	0,55	4	1400	67	0,87	1,3	3,7	4,4	2,1	0,00400	16,5
	2,20	2	2860	70	0,89	5	7,5	4,4	1,9		
100MC	0,62	4	1420	73	0,89	1,42	4,2	5,3	2,0	0,00500	20
	2,60	2	2820	77	0,92	5,3	8,8	5,6	2,1		
100LC	0,75	4	1415	73	0,90	1,6	5,1	5	2,0	0,00750	22
	3,30	2	2800	78	0,92	6,64	11,3	5,6	2,1		
112MC	4,40	2	2890	76	0,95	8,5	14,6	5,4	2,0	0,00860	37
	1,10	4	1440	76	0,90	2,3	7,4	5	1,9		
132SC	2	4	1450	75	0,81	4,7	13,1	5,9	2,1	0,02311	42
	6,5	2	2890	83	0,92	12,4	21,5	6,1	2,2		
132MC	2,5	4	1440	89	0,80	4,9	16,5	6,4	2,3	0,02953	56
	8,5	2	2900	91	0,83	15,9	28,2	6,7	2,3		
132LC	2,8	4	1440	85	0,83	5,6	18,6	6,5	2,3	0,03200	60
	9,2	2	2900	88	0,85	17,4	30,5	6,8	2,4		

THREE PHASE MOTORS 2 SPEED - QUADRATIC TORQUE - 750/1500
400V 50Hz

Tipo Type	(kW)	Poli Poles	rpm	η	$\cos\phi$	I_N (A)	M_N (Nm)	I_A/I_N	M_A/M_N	J_{rotor} (kgm ²)	(kg)
71AD	0,05	8	700	28	0,68	0,36	0,7	2,3	2,8	0,00180	7
	0,25	4	1400	70	0,75	0,69	1,7	3,0	2,2		
71BD	0,07	8	680	33	0,70	0,45	1,1	1,4	1,2	0,00200	7,5
	0,37	4	1380	59	0,80	1,1	2,6	2,5	1,2		
80AD	0,10	8	700	38	0,66	0,58	1,4	2,0	2,3	0,00230	10
	0,55	4	1405	75	0,74	1,43	3,7	4,4	2,2		
80BD	0,15	8	690	48	0,66	0,7	2,1	2,4	1,5	0,00300	11
	0,75	4	1410	70	0,76	1,9	5,1	4,1	1,7		
90SD	0,25	8	710	54	0,70	0,96	3,4	2,9	2,8	0,00430	13,5
	0,90	4	1415	77	0,75	2,75	6,1	4,0	2,3		
90LD	0,30	8	710	57	0,70	1,1	4,0	1,3	3,0	0,00480	16,5
	1,20	4	1420	80	0,79	3,4	8,1	4,2	2,3		
100MD	0,45	8	710	61	0,68	1,6	6,1	3,0	2,0	0,00770	20
	1,90	4	1390	80	0,80	4,1	13,1	5,0	3,0		
100LD	0,55	8	720	68	0,70	1,68	7,3	3,0	2,4	0,00860	22
	2,20	4	1440	84	0,85	4,86	14,6	6,0	2,5		
112MD	0,75	8	720	70	0,68	2,27	9,9	3,0	2,4	0,01200	37
	3,00	4	1450	83	0,85	6,6	19,8	6,0	2,6		
132SD	1,1	8	710	72	0,73	3,1	15	3,5	1,9	0,03000	50
	4,4	4	1450	85	0,82	9,2	29,0	5,8	2,2		
132MD	1,5	8	700	79	0,64	4,33	20	3,9	1,8	0,04000	55
	5,9	4	1440	86	0,84	11,9	39	6,2	2,1		
132LD	1,85	8	700	80	0,7	4,9	25,0	4,3	1,9	0,04500	59
	7,5	4	1450	87	0,84	14,9	50,0	6,7	2,1		

THREE PHASE MOTORS 2 SPEED - QUADRATIC TORQUE - 1000/1500

400V 50Hz

Tipo Type	(kW)	Poli Poles	rpm	η	$\cos\phi$	I_N (A)	M_N (Nm)	I_A/I_N	M_A/M_N	J_{rotor} (kgm ²)	(kg)
71BE	0,10	6	900	63	0,72	0,50	1,4	1,4	1,8	0,00080	7,5
	0,30	4	1400	71	0,75	0,95	2,1	2,6	2,0		
80AE	0,13	6	900	33	0,7	0,50	1,4	1,7	1,1	0,00220	10
	0,44	4	1405	59	0,8	1,02	3,0	3,2	1,5		
80BE	0,18	6	905	72	0,75	0,65	1,9	2,3	1,2	0,00282	11
	0,59	4	1405	76	0,8	1,60	3,9	3,5	1,7		
90SE	0,30	6	900	68	0,76	0,83	3,1	3,1	1,6	0,00265	13,5
	0,90	4	1400	77	0,75	2,25	6,1	4,1	2,1		
90LE	0,40	6	910	74	0,74	1,10	4,2	2,9	1,3	0,00342	16,5
	1,15	4	1420	80	0,79	2,60	7,5	4,1	1,8		
100ME	0,60	6	930	80	0,75	1,44	6,1	3,9	1,8	0,00775	20
	1,80	4	1410	80	0,83	3,67	12,1	5,1	2,1		
100LE	0,70	6	940	80	0,75	2,10	7,5	3,0	1,5	0,01033	22
	2,20	4	1440	82	0,87	4,90	15,2	3,8	1,7		
112ME	0,90	6	940	81	0,79	2,00	9,1	4,0	1,9	0,01603	37
	3,00	4	1450	84	0,82	6,30	19,8	5,5	2,0		
132KE	1,2	6	945	80	0,75	2,9	11,8	4,9	1,7	0,03223	48
	4	4	1450	84	0,82	8,4	26	6,3	2,1		
132SE	1,4	6	970	69	0,6	5,00	14,0	5,2	1,9	0,03600	54
	4,8	4	1460	75	0,81	11,30	31,2	6,6	1,9		
132ME	1,7	6	960	64	0,62	6,4	17	4,8	1,9	0,03800	59
	5,5	4	1455	77	0,81	12,8	36	5,4	2,1		
132LE	2	6	950	78	0,55	7,90	20,1	5,2	1,9	0,04000	62
	6,6	4	1460	89	0,72	15,30	43,2	6,7	1,9		

THREE PHASE MOTORS 2 SPEED - QUADRATIC TORQUE - 750/1000

400V 50Hz

Tipo Type	(kW)	Poli Poles	rpm	η	$\cos\phi$	I_N (A)	M_N (Nm)	I_A/I_N	M_A/M_N	J_{rotor} (kgm ²)	(kg)
80BF	0,09	8	680	57	0,62	0,4	1,3	1,9	1,4	0,00220	10
	0,33	6	920	55	0,70	1,32	3,4	3,1	1,8		
80BF	0,12	8	685	55	0,63	0,5	1,7	2,1	1,4	0,00282	11
	0,40	6	935	58	0,70	1,48	4,0	2,9	1,8		
90SF	0,19	8	690	55	0,62	0,85	2,7	2,1	1,5	0,00265	13,5
	0,48	6	925	61	0,65	1,78	4,8	3,1	1,9		
90LF	0,25	8	700	52	0,62	1,2	3,5	2,3	1,7	0,00342	16,5
	0,66	6	900	60	0,80	2	7,1	3,2	2,0		
100MF	0,37	8	720	50	0,65	1,75	4,8	3,5	1,8	0,00775	20
	0,90	6	960	67	0,68	2,85	8,9	4,1	1,9		
100LF	0,45	8	720	52	0,64	2,1	5,9	3,4	1,4	0,01033	22
	1,10	6	950	70	0,70	3,35	11,2	3,9	1,6		
112M	0,75	8	720	61	0,68	2,8	10,1	3,5	1,7	0,01603	37
	1,50	6	970	75	0,74	3,9	15,1	4,4	2,1		
132SF	0,9	8	720	62	0,66	3,2	11,9	3,7	1,8	0,03600	54
	2,2	6	960	75	0,75	5,6	22,2	4,4	2,2		
132MF	1,2	8	730	61	0,63	4,8	15,6	3,8	1,8	0,03800	59
	3	6	970	77	0,82	6,9	29,7	4,8	2,1		
132LF	1,5	8	720	65	0,7	4,9	20,1	3,8	2,1	0,04000	62
	3,7	6	970	80	0,77	8,8	36,5	5,1	2,1		

SINGLE PHASE MOTORS 1 SPEED RUNNING CAPACITOR - 3000

230V 50Hz

Tipo Type	(kW)	rpm	η	$\cos\phi$	I_N (A)	M_N (Nm)	I_A/I_N	M_A/M_N	M_{max}/M_N	C(μ F)	J_{rotor} (kgm ²)	(kg)
56B2	0,12	2880	46%	0,94	1,3	0,4	2,3	1	1,9	8	0,00030	6
63A2	0,18	2870	55%	0,99	1,5	0,6	2,3	0,6	2,1	12,5	0,00030	6
63B2	0,25	2800	60%	0,95	1,81	0,85	2,6	0,6	1,7	12,5	0,00035	6
71A2	0,37	2860	65%	0,95	2,56	1,23	3,6	0,7	2,0	16	0,00046	7,5
71B2	0,55	2840	66%	0,99	3,42	1,85	3,3	0,7	2,0	25	0,00056	8
80A2	0,75	2860	70%	0,99	4,55	2,52	3,8	0,7	1,8	30	0,00097	9,5
80B2	1,1	2820	70%	0,99	6,8	3,7	2,8	0,7	2,0	30	0,01000	11
90S2	1,5	2810	67%	0,99	9,75	5,1	2,7	0,6	1,7	70	0,00150	14
90L2	2,2	2815	69%	0,99	14,5	7,62	2,8	0,7	1,5	90	0,00190	16
100M2	2,2	2710	71%	0,99	14,4	7,4	2,5	0,55	1,7	95	0,00370	25
100L2	3	2815	66%	0,9	17,8	10	3,6	0,6	1,8	120	0,00530	27
112M2	4	2890	69%	0,97	26	13,2	3,6	0,65	1,8	120	0,00700	40

SINGLE PHASE MOTORS 1 SPEED RUNNING CAPACITOR - 1500

230V 50Hz

Tipo Type	(kW)	rpm	η	$\cos\phi$	I_N (A)	M_N (Nm)	I_A/I_N	M_A/M_N	M_{max}/M_N	C(μ F)	J_{rotor} (kgm ²)	(kg)
56B4	0,09	1420	55%	0,97	0,8	0,59	3,0	0,7	2,1	6,3	0,00038	5
63A4	0,12	1380	55%	0,95	1,1	0,84	2,3	0,7	2,5	8	0,00040	5
63B4	0,18	1360	59%	0,99	1,38	1,27	1,8	0,6	1,2	10	0,00045	5,5
71A4	0,25	1450	59%	0,96	2	1,66	4	0,55	2,5	16	0,00080	8
71B4	0,37	1430	65%	0,99	2,55	2,5	3,1	1,1	1,7	20	0,00090	8,5
80A4	0,55	1440	69%	0,96	3,7	3,7	3,5	0,6	2,0	25	0,00096	10
80B4	0,75	1410	70%	0,99	4,74	5,1	2,6	0,6	1,5	30	0,00120	12
90S4	1,1	1440	68%	0,94	7,6	7,4	3,4	0,5	2	40	0,00260	15
90L4	1,5	1430	69%	0,99	9,4	10,1	2,8	0,5	1,5	45	0,00320	18
100M4	2,2	1430	70%	0,96	12,6	14,9	3,8	0,55	1,6	55	0,00590	25
112M4	3	1410	75%	0,98	17	20	3,9	0,45	1,8	70	0,01200	37

SINGLE PHASE MOTORS 1 SPEED RUNNING CAPACITOR - 1000

230V 50Hz

Tipo Type	(kW)	rpm	η	$\cos\phi$	I_N (A)	M_N (Nm)	I_A/I_N	M_A/M_N	M_{max}/M_N	C(μ F)	J_{rotor} (kgm ²)	(kg)
71A6	0,12	910	61%	0,95	1,30	1,2	2,5	0,6	1,4	8	0,00080	8
71B6	0,18	930	61%	0,95	1,60	1,8	2,7	0,6	1,4	12,5	0,00090	8,5
80A6	0,25	955	62%	0,96	2,10	2,2	2,6	0,6	1,4	16	0,00096	10
80B6	0,37	920	65%	0,99	2,75	3,2	2	0,7	1,8	20	0,00120	12
90S6	0,55	930	65%	0,99	3,86	5,9	2,4	0,7	1,7	30	0,00260	15
90L6	0,75	920	68%	0,99	4,81	8,1	2,2	0,7	1,9	35	0,00320	18
100M6	1,10	920	69%	0,90	8,10	11,5	3,1	0,7	1,9	45	0,00590	25

8

OVERALL DIMENSIONS

IM B3 Ex d

Size	B	A	HA	BB	AB	AC	AD	AE	C	H	HD	L	LR	K1	K2	M	D	E	GA	F	DB
56	*	*	*	*	*	121	150	119	*	*	*	210	220	*	*	M20	9	20	10,2	3	M4X10
63	80	100	10	105	120	121	150	119	40	63	203	200	210	7	12	M20	11	23	12,5	4	M4X10
71	90	112	11	108	136	136	159	119	45	71	220	225	235	7	12	M20	14	30	16	5	M5X25
80	100	125	11	125	154	154	163	119	50	80	243	245	255	9,5	17,5	M20	19	40	21,5	6	M6X16
90S	100	140	13	130	174	174	173	119	56	90	263	260	270	9,5	17,5	M20	24	50	27	8	M8X19
90L	125	140	13	155	174	174	173	119	56	90	263	285	295	9,5	17,5	M20	24	50	27	8	M8X19
100	140	160	14	175	192	192	186	119	63	100	286	315	327	11,2	21,2	M20	28	60	31	8	M10X22
112	140	190	14	175	224	216	195	119	70	112	307	338	352	11,2	21,2	M20	28	60	31	8	M10X22
132S	140	216	17	180	260	255	221	136	89	132	353	378	418	12,5	30	M25	38	80	41	10	M12X28
132L	178	216	17	218	260	255	221	136	89	132	353	432	445	12,5	30	M25	38	80	41	10	M12X28

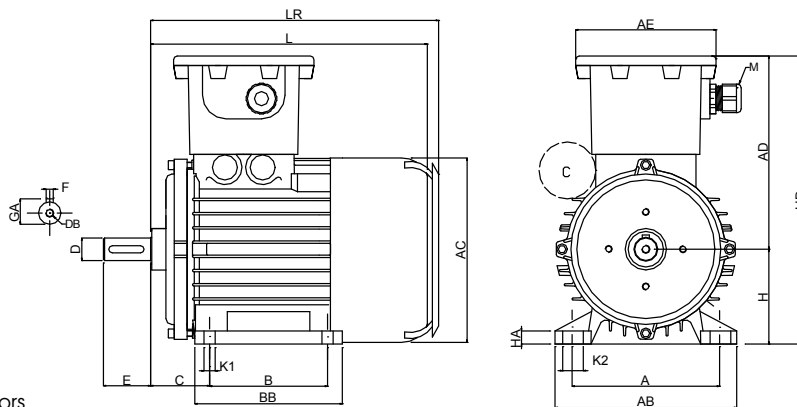

*: Size 56 only flanged motors
C: Exd enclosure for capacitor

IM B3 Ex de

Size	B	A	HA	BB	AB	AC	AD	AE	C	H	HD	L	LR	K1	K2	M	D	E	GA	F	DB
56	*	*	*	*	*	121	113	101	*	*	*	210	220	*	*	M20	9	20	10,2	3	M4X10
63	80	100	10	105	120	121	113	101	40	63	176	200	210	7	12	M20	11	23	12,5	4	M4X10
71	90	112	11	108	136	136	122	101	45	71	193	225	235	7	12	M20	14	30	16	5	M5X25
80	100	125	11	125	154	154	143	114	50	80	223	245	255	9,5	17,5	M20	19	40	21,5	6	M6X16
90S	100	140	13	130	174	174	148	114	56	90	238	260	270	9,5	17,5	M20	24	50	27	8	M8X19
90L	125	140	13	155	174	174	188	114	56	90	238	285	295	9,5	17,5	M20	24	50	27	8	M8X19
100	140	160	14	175	192	192	159	114	63	100	259	315	327	11,2	21,2	M20	28	60	31	8	M10X22
112	140	190	14	175	224	216	171	114	70	112	283	338	352	11,2	21,2	M20	28	60	31	8	M10X22
132S	140	216	17	180	260	255	194	124	89	132	326	395	418	12,5	30	M25	38	80	41	10	M12X28
132L	178	216	17	218	260	255	194	124	89	132	326	432	445	12,5	30	M25	38	80	41	10	M12X28

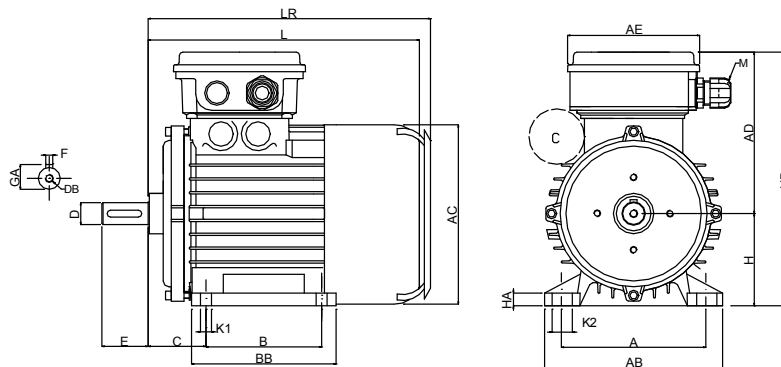

*: Size 56 only flanged motors
C: Exd enclosure for capacitor

IM B5 Ex d - Ex de

Size	∅ P	∅ N	LA	M	T	S
56	120	80	10,5	100	3	7
63	140	95	10,5	115	3	9
	160*	110	10,5	130	3,5	9
71	140*	95	10,5	115	3	9
	160	110	10,5	130	3,5	9
	200*	130	11,5	165	3,5	12
80	160*	110	10,5	130	3,5	9
	200	130	11,5	165	3,5	12
90	160*	110	10,5	130	3,5	9
	200	130	11,5	165	3,5	12
100	200*	130	11,5	165	3,5	12
	250	180	15	215	4	13
112	200*	110	10,5	130	3,5	9
	250	180	15	215	4	13
132	250*	180	20	215	4	13
	300	230	20	265	4	13

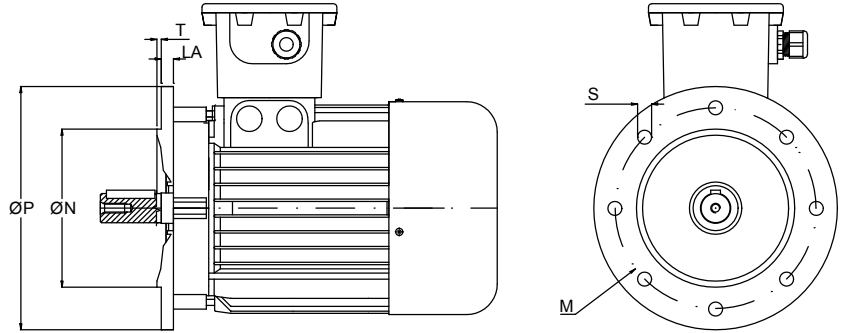

*Reduced or enlarged flange version

IM B14 Ex d - Ex de

Size	∅ P	∅ N	LA	M	T	S
56	80	50	13	65	2,5	M5
63	90	60	13	75	2,5	M5
	105*	70	13	85	2,5	M6
71	90*	60	13	75	2,5	M5
	105	70	13	85	2,5	M6
	120*	80	13	100	3	M6
80	105*	70	15	85	2,5	M6
	120	80	15	100	3	M6
	140*	95	15	115	3	M8
90	120*	80	15	100	3	M6
	140	95	15	115	3	M8
	160*	110	16	130	3,5	M8
100	140*	95	15	115	3	M8
	160	110	16	130	3,5	M8
112	140*	95	15	115	3	M8
	160	110	16	130	3,5	M8
132	160	110	20	130	3,5	M8
	200	130	20	165	4	M10

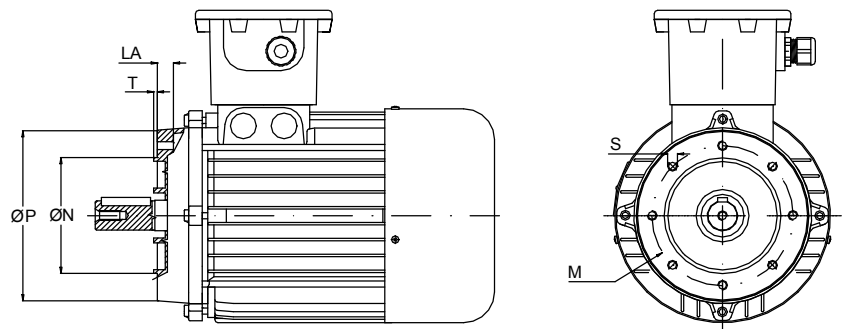

*Reduced or enlarged flange version





www.orange1.eu

Manufactured by
ELPROMtech Srl
Via Mantova, 93
43122 - Parma
Italy

info@orange1.eu

Tel. +39 0521 272383
Fax +39 0521 272686

ORANGE[®]

